

Druck DPI 104-IS

Intrinsically safe digital pressure indicator

User manual - K0436



© Copyright 2020. Baker Hughes Company. This material contains one or more registered trademark of Baker Hughes Company and its subsidiaries in one or more countries. All third-party product and company names are trademarks of their respective holders.

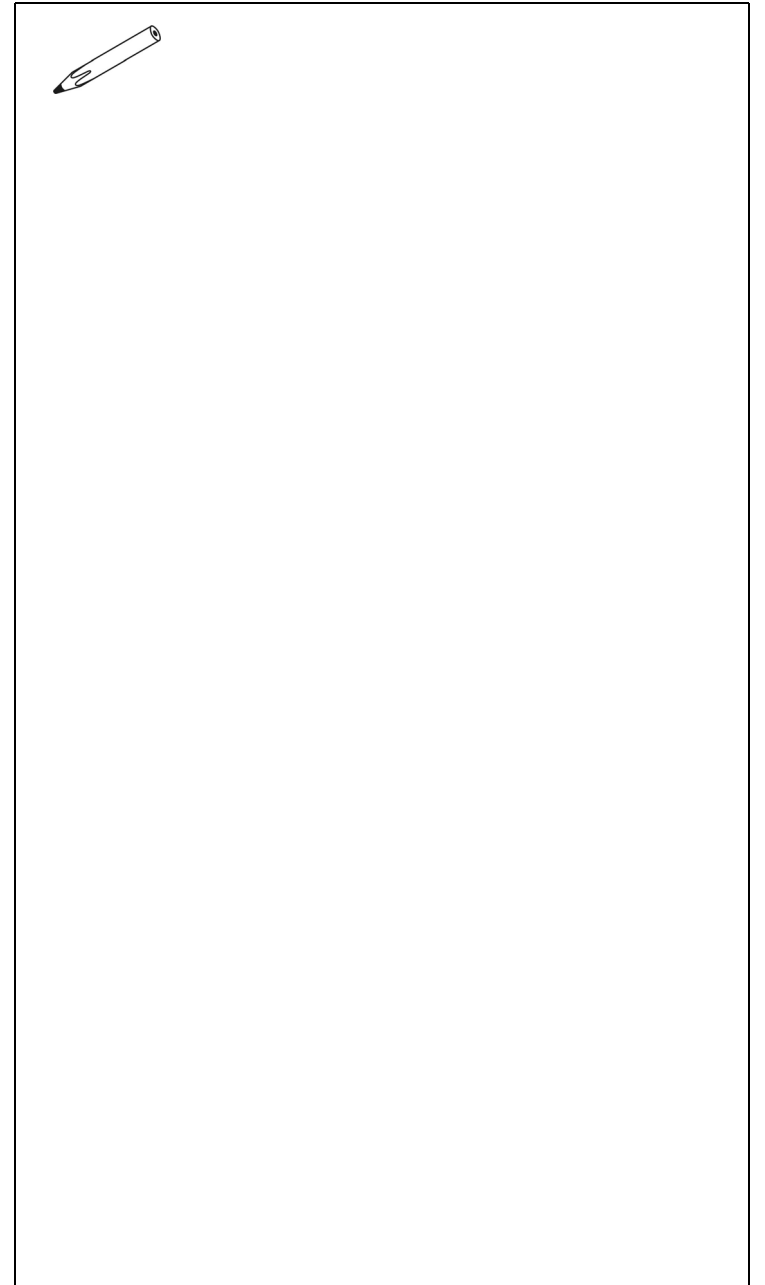

L1	 II 1 G Ex ia IIC T4 Ga (-10°C ≤ Ta ≤ +50°C) ITS07ATEX25517X	(† 1)
	IECEX ITS 07.0007X	(† 2)
	WARNING: REPLACE BATTERY IN SAFE AREA ONLY	(† 3)

L2	Druck, LE6 0FH, UK  1180	(† 4)
	***** (20 bar g)	(† 5)
	DoM: mm/yy (06/07)	(† 6)
	S/N: *****	(† 7)

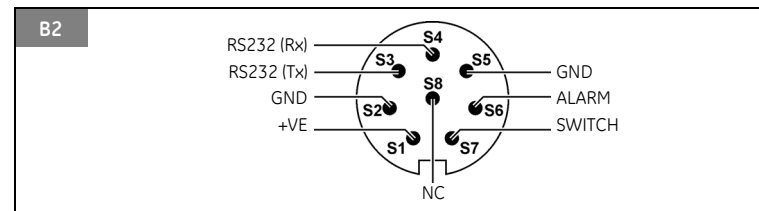
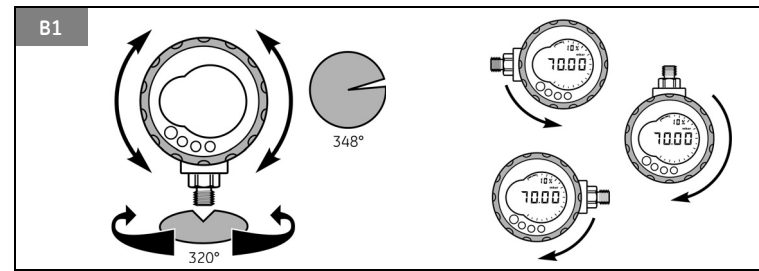
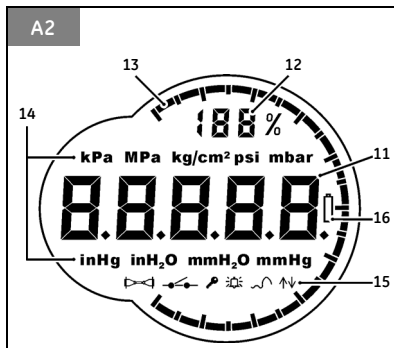
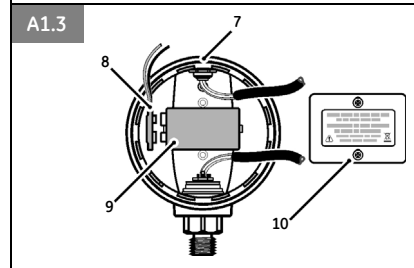
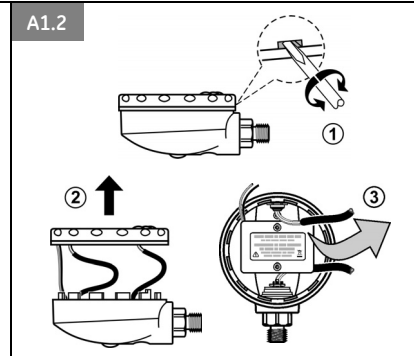
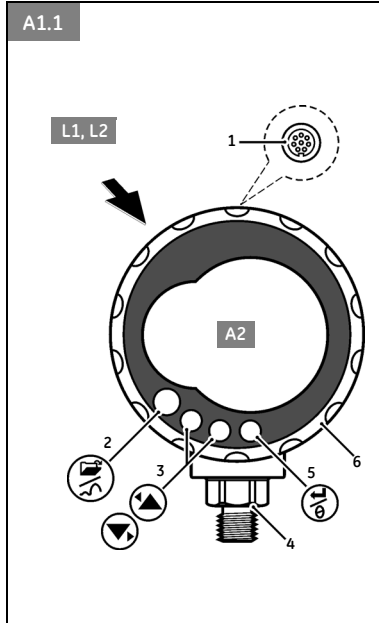

		U _i (V)	I _i (mA)	P _i (mW)	C _i	L _i
S2-S1	+VE	16.9	22	210	0	1.6 μH
S2-S6	ALARM	16.9	22	210	0.1 nF	0
S2-S7	SWITCH	0	0	0	0	0
S2-S3	RS232 (Tx)	16.2	4.75	210	440 nF	0
S2-S4	RS232 (Rx)	16.2	4.75	210	440 nF	0
		U _o (V)	I _o (mA)	P _o (mW)	C _o	L _o
S2-S1	+VE	0	0	0	0	0
S2-S6	ALARM	5	0.5	0.69	99.9 μF	1 H
S2-S7	SWITCH	5	6.75	8.5	100 μF	1 H
S2-S3	RS232 (Tx)	10	14	260	2 nF	0.41 H
S2-S4	RS232 (Rx)	10	14	260	2 nF	0.41 H

Customer service

Visit our web site: www.gesensinginspection.com

Quick Reference

WARNING: Before using this instrument, read and understand the “Safety” section. It is dangerous to ignore the specified warnings.

Power on sequence

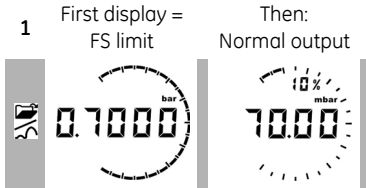

Power off sequence

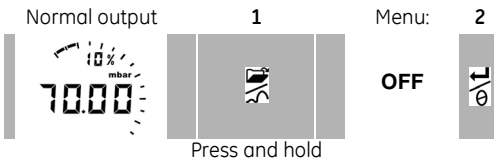

Change the pressure units

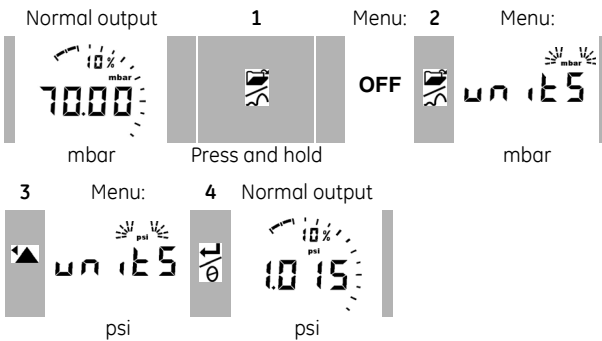

Set the DPI 104-IS to zero

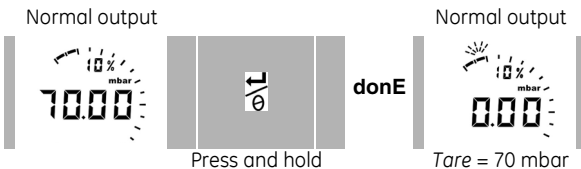

Menu sequence





Menu Description [Options]	Steps		Menu Description [Options]	Steps	
	1	2		1	2
 OFF	= Power supply off: Page 1/7. [OFF]	0/T -	 Au On	= Set automatic power OFF: Page 16. [OFF, On + value]	▲/▼ 0/T
units	= Set units: 24/11. [A2: item 14]	▲/▼ 0/T	L OFF	= Set lock code: Page 16. [OFF, On + value]	▲/▼ 0/T
t On	= Set tare (or set zero): Page 1/12. [On or OFF, On + value]	▲/▼ 0/T	 Sc 02	= Set scan rate: Page 17. [value]	▲/▼ 0/T
 OFF	= Monitor maximum/minimum: Page 13. [On or OFF]	▲/▼ 0/T	FS ↓	= Set FSO low register: Page 17. [value]	▲/▼ 0/T
OFF	= Monitor a pressure switch: Page 13. [On or OFF]	▲/▼ 0/T	FS ↑	= Set FSO high register: Page 17. [value]	▲/▼ 0/T
C _ _ _	= Calibration: Page 20.	▲/▼ 0/T	Normal display		
A OFF	= Set low/high alarm: Page 14. [OFF, On + value]	▲/▼ 0/T			
	(Continued)				

Table of Contents

Front cover:	Operation 11
L1/L2: Explosion protection markings	Menu: Set units 11
A1: Parts of the instrument/battery access	Menu: Set tare (or set zero) 12
A2: Parts of the display	Menu: Monitor maximum/minimum 13
B1: Permitted bezel/connector angles	Menu: Monitor a pressure switch 13
B2: Maximum permitted electrical values	Menu: Calibration 14
Quick Reference 1	Menu: Set low/high alarm 14
Power on sequence 1	Menu: Set automatic power OFF 16
Power off sequence 1	Menu: Set lock code 16
Change the pressure units 1	Menu: Set scan rate 17
Set the DPI 104-IS to zero 1	Menu: Set FSO low/high registers 17
Menu sequence 2	Software connections 18
Table of Contents 3	Error indications 19
Introduction 4	Maintenance 19
Safety 4	Replace the batteries 19
Special conditions for safe use 5	Restore the original configuration 19
Marks and symbols 5	Calibration 20
To Start 6	Equipment and conditions 20
Key to figure A1 (Instrument) 6	Procedures 20
Key to figure A2 (Display) 7	Specification 23
Prepare the instrument 7	General 23
Power on or off 7	Electrical 23
Menu operation 8	Pressure measurement 24
Installation 9	EC Declaration of conformity A-1
DPI 104-IS battery 9	Approvals - ATEX B-1
DPI 104-IS position 9	Approvals - IECEx B-9
Pressure connections 10	Customer service Back cover
Electrical connections 11	

© 2010 General Electric Company. All rights reserved.

Trademarks

All product names are trademarks of their respective companies.

Introduction

The data that follows applies to the Druck DPI 104-IS with the specified marking details. Refer to Marks and Symbols.

The Druck DPI 104-IS digital pressure indicator measures the pressure of liquid, gas or vapour and shows the pressure value on a liquid crystal display (LCD). The DPI 104-IS is designed to operate in the "hazardous areas" specified by the certification markings (Refer to "Marks and symbols").

Note: In this document, "hazardous areas" includes potentially explosive atmospheres, hazardous (classified) locations, explosive gas atmospheres.

The DPI 104-IS includes these functions:

Function
* Measure pressure - Accuracy: 0.05% full-scale (FS)
Large 5-digit main display with 11 pressure units
Adjustable Full-Scale Output (FSO)
20 segment analogue dial in increments of 5% FSO (large division marks = 10% increments).
2.5 digit percentage indicator (0-100% FSO)
8-pin connector port: For RS232, external power supply
Alarm output for high/low pressure conditions
Switch input to monitor an external pressure switch
Other functions: Maximum/minimum, tare, automatic power off

* Refer to Specifications.

Safety

Before installing and using the DPI 104-IS, read and understand all the related data. This includes: all local safety procedures and installation standards (for example: EN 60079-14), and this document.

WARNING

- **Do not open the DPI 104-IS when an explosive atmosphere is present - this can cause an explosion.**
- **Do not use tools on the DPI 104-IS that might cause incendive sparks - this can cause an explosion.**
- **Do not connect an energised electrical circuit in a hazardous area while explosive atmospheres are present - this can cause an explosion. Isolate the power supply to the equipment first.**

Continued

Safety (Continued)

- Batteries can cause incendive sparks. Install the battery in a safe area only. Use only Duracell® Procell® MN1604.
- Some liquid and gas mixtures are dangerous. This includes mixtures that occur because of contamination. Make sure that the DPI 104-IS is safe to use with the necessary media.
- It is dangerous to ignore the specified limits for the DPI 104-IS or to use the DPI 104-IS when it is not in its normal condition. Use the applicable protection and obey all safety precautions.
- To prevent a dangerous release of pressure, isolate and bleed the system before disconnecting a pressure connection.

Note: In this document, a "safe area" includes non-hazardous location, unclassified area.

To install and use the DPI 104-IS in a hazardous area, use only approved engineers who have the necessary skills and qualifications.

Special conditions for safe use

When the power supply for the DPI 104-IS is through the 8-pin connector, use only a Type A or a Type B cable as specified in IEC 60079-14.

Marks and symbols

Refer to figures L1 and L2 to see the certificate details related to explosion protection.

Notes (†):

(† 1) ATEX certification markings

(† 2) IECEx certification markings

(† 3) Warning text:

WARNING: REPLACE BATTERY IN SAFE AREA ONLY

(† 4) Name and address of the manufacturer



(† 5) Pressure range. Example: 20 bar g

(g: gauge; a: absolute; sg: sealed gauge)

(† 6) Date of manufacture (month/year)

(† 7) Serial number for the instrument



Other marks and symbols

	Complies with European Union directives
	Warning - refer to the manual
	Do not dispose of this product as household waste. Refer to Maintenance.

To Start











Key to figure A1
(Instrument)

Table 1: Key to figure A1

Item	Description
1.	8-pin connector for external power supplies, RS232 connections and signal input/output.
2. •	Power on button
	Menu mode: Press and hold to show the first menu option. To move down the menu structure, press again and again, or continue to press and hold.
•	Reject or stop the change to a value.
•	In maximum/minimum mode. Press to show the maximum and minimum values since the last reset. ↶ ↑ = maximum ↷ ↓ = minimum
3.	In menu mode: - On/OFF selection - Move the decimal left/right - Increase/decrease a value
4.	Pressure sensor and connector with 320° of turn: gauge (g), absolute (a) or sealed gauge (sg). Refer to Specification.
5. •	In menu mode: - Accepts a menu selection - Accepts a value - Shows the next menu level
•	In Tare mode: Set the pressure value on the display to zero.
•	In maximum/minimum mode. Reset the maximum/minimum values.
6.	Display bezel with 348° of turn.
7.	O-ring.
8.	Battery connector
9.	Battery: Supplied but not installed; refer to Installation.
10.	Battery cover/clamp with two screws and a label: REPLACE BATTERY IN SAFE AREA ONLY USE ONLY DURACELL PROCELL MN1604 REPLACEZ LES PILES UNIQUEMENT EN ZONES NON-DANGEREUSES. UTILISER UNIQUEMENT LE MODELE DURACELL PROCELL MN1604  

**Key to figure A2
(Display)**

Table 2: Key to figure A2

Item	Description
11.	5-digit main display.
12.	2.5-digit percentage indicator (0-100% FSO). %FSO = [Applied Pressure / (FSO High – FSO Low)] * 100
13.	20 segment analogue dial in increments of 5% FSO (large division marks = 10% increments). %FSO = [Applied Pressure / (FSO High – FSO Low)] * 100
14.	The units of measurement: kPa, MPa, kg/cm ² , psi, mbar, bar, mmHg, mmH ₂ O, mH ₂ O, inH ₂ O, inHg
15.	Mode indication.
	 RS232 connection. The data transmit/receive function is active.
	 Switch mode - On. To monitor an external pressure switch.  = switch closed  = switch open
	 Menu Lock mode - On. To restrict access to the menu functions.
	 Alarm mode - On. The symbol flashes when the measured value satisfies one of the alarm conditions.  ↑ = High alarm  ↓ = Low alarm
 Maximum/minimum mode - On.	
16. 	Low battery power indication: Battery life ≤ 15%.

Prepare the instrument

Before using the instrument for the first time:

- Make sure that there is no damage to the instrument, and that there are no missing items.
- Install the battery (refer to Installation). Then re-attach the display bezel [A1: item 6].



















































Power on or off

Refer to Quick Reference.

When the power is off, the last set of configuration options stays in memory.

Note: The DPI 104-IS uses a small quantity of power while it is OFF. If placing in storage for a long period, disconnect the battery (refer to "Installation").

Menu operation

	Menu Description	Steps		Result/Subsequent steps
		1	2	
 OFF	= Power supply: OFF only	 	-	Power goes off
units	= Set units: (A2: item 14).	 	 	Pressure value changes to the applicable units: psi, mbar, bar ...
t On	= Set tare (or set zero): Set to On or OFF.	 	 	On ► tA 00.000 : Set a tare value (Refer to Table 6)
OFF 	= Monitor maximum/minimum: Set to On or OFF	 	 	Monitor function is set on or off
OFF 	= Monitor a pressure switch: Set to On or OFF.	 	 	Monitor function is set on or off
C	= Calibration: To continue, set the correct calibration access code = last four digits of S/N. *****	 	 	C0 (Correct the zero offset value) ► C2 (Do a two-point pressure calibration) . Refer to Calibration.
A OFF 	= Set low/high alarm: Set to On or OFF.	 	 	On ► 000.0 ↓ ► 100.0 ↑ Set a value for the low and/or high alarm (0 to 105% FSO).
Au On	= Set automatic power OFF: Set to On or OFF.	 	 	On ► Au 15 : Set the period for automatic power OFF (1 to 99 minutes). Factory value = 15 minutes.
L OFF 	= Set lock code: A menu protection facility. Set to On or OFF.	 	 	On ► L 000 : Set a new lock code (if necessary). Factory code = 000.
Sc 02	= Set scan rate: A rate that the DPI 104-IS uses to take pressure samples.	 	 	Set an applicable rate (02 to 10 Hz). Factory value = 02 Hz.
FS ↓	= Set FSO low register: To set a different range for these functions: analogue display, %, alarm.	 	 	Set a value for the low end of the range (refer to Table 7). Factory value = Factory calibration value.
FS ↑	= Set FSO high register: To set a different range for these functions: analogue display, %, alarm.	 	 	Set a value for the high end of the range (refer to Table 7). Factory value = Factory calibration value.

Normal display

Installation

This section shows how to install and connect the DPI 104-IS.
Before starting:

- Read and understand the Safety section.
- Do not use a damaged DPI 104-IS.

The materials that are used in the DPI 104-IS are specified in the Specification section. Make sure that the materials are applicable for the installation.

DPI 104-IS battery

To install the battery follow the procedures in Table 3.

WARNING: Batteries can cause incendive sparks. Install the battery in a safe area only. Use only Duracell® Procell® MN1604.

Table 3: *Installation procedures - Battery*

Step	Procedure
1	If applicable, set the power to off and isolate the external power supply.
2	Figure A1.2: Remove the display bezel (①, ②) and the battery cover/clamp (③).
3	Make sure that the o-ring [A1: item 7] and the related surfaces are serviceable. Use only original parts supplied by the manufacturer.
4	If applicable, disconnect the battery connector [A1: item 8] and *discard the used battery.
5	Attach the battery connector [A1: item 8] to the new battery.
6	Install the new battery (Figure A1.3) and re-attach the battery cover/clamp [A1: item 10].
7	Push the display bezel [A1: item 6] back into position until it is fully engaged.

* Use an applicable recycling facility.

DPI 104-IS position

Attach the DPI 104-IS in a safe configuration that prevents unwanted stress (for example vibration, physical impact, shock, mechanical and thermal stresses). Do not install the equipment where it can be damaged by a material that causes corrosion. Provide additional protection for equipment that may be damaged in service.

To get the best installation position, turn the pressure connector (A1: item 4) and the display bezel (A1: item 6) to give the best view of the display (Figure B1). End stops set the limits in each axis.

CAUTION: To prevent damage when setting the best view of the display, do not use force to turn the pressure connector or the bezel farther than the end stops.

Pressure connections

CAUTION: To prevent damage, do not use the body of the DPI 104-IS to tighten the pressure connection. Use the flat faces on the pressure connector.

Use an applicable method to seal the pressure connections, and then tighten to the applicable torque (Figure 1 and Table 4).



a) 1/4 NPT:
Pressure < 1000 bar (15000 psi)

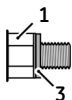

b) G1/4:
Pressure < 1000 bar (15000 psi)



c) 9/16 x 18 UNF cone:
Pressure ≥ 1000 bar (15000 psi)

Figure 1: Connection methods

Table 4: Key to figure 1

Item	Description
1.	Applicable DPI 104-IS pressure connector. Maximum torque: 1/4 NPT: 68 Nm (50 lbf.ft) G1/4: 20 Nm (15 lbf.ft) 9/16 x 18 UNF cone: 34 Nm (25 lbf.ft)
2.	(1/4 NPT only) Thread with an applicable sealant
3.	(G1/4 only) Applicable bonded seal

Electrical connections

The DPI 104-IS includes an 8-pin electrical connector (A1: item 1). Table 5 shows the pin connections.

Table 5: Connections for the 8-Pin connector

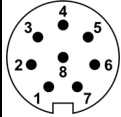
Connector	Pin	Input/Output	Description
	1.	Input	15 Vdc power supply (+VE)
	2.	Input	Signal ground (GND)
	3.	Output	RS232 transmit (Tx)
	4.	Input	RS232 receive (Rx)
	5.	-	Signal ground (GND)
	6.	Output	Alarm output (ALARM)
	7.	Input	Pressure switch input (SWITCH)
	8.	-	No connection (NC)

Make sure the connections to the DPI 104-IS are from intrinsically safe (IS) safety barriers or an IS supply.

Figure B2 gives the maximum permitted input and output values.

Connect the earth/ground connections that are applicable to the installation. If applicable, make sure that the cable screen is isolated from the DPI 104-IS.

The DPI 104-IS is resistant to an AC test voltage of 500 V RMS as specified in EN 60079-11.

External power

We recommend an external power supply for these functions and operations:

- Functions: Maximum/minimum, switch, low/high alarm.
- Operations that use the DPI 104-IS for long periods.

Operation

This section shows how to use the DPI 104-IS. Before starting:

- Read and understand the Safety section.
- Make sure that the installation is complete (refer to the Installation section).
- Do not use a damaged DPI 104-IS.

Menu: Set units

There are 11 different units to measure pressure (refer to the Specification section).

Units - Set-up

Refer to Quick Reference.

Menu: Set tare (or set zero)

Use the tare function to adjust the pressure value on the display. For example: To make an adjustment for atmospheric pressure (refer to Table 6).

Table 6: Permitted tare values

Range	Permitted tare values
g: 0.7 bar (10 psi)	-0.7 bar (-10 psi) to 105% FS
a, sg, g: ≥ 2 bar (30 psi)	-1 bar (-15 psi) to 105% FS

Setting a value that is not in the permitted range, the value goes back to the last accepted value.

Tare - Set-up and use

Menu: Set this function to *On* (refer to Menu Operation).

When this function is *On*, there are two options to set a tare value (τA):

- *Menu option:* Set the menu " τ On", then set a τA value:

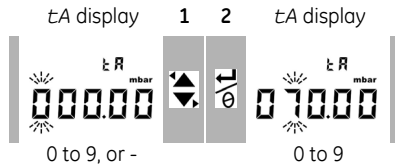

Repeat steps **1 + 2** for each digit and for the decimal point.

- *Zero option:* Step **1** sets a value for τA . Press and hold.

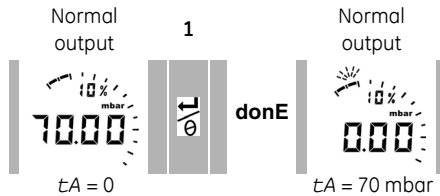

When τA is not zero, the last segment on the analogue dial flashes.

To make sure that there is an indication of the correct pressure while tare is *On*, the analogue dial and % indication show values calculated from the calibrated range without the tare adjustment.

Tare - With lock

If the menu lock is *On* with a lock code set < 500 , the zero option is rejected - Error code (E0002).

Tare - With alarm

Use the zero option to set a tare value (tA) while the alarm is *On*, the display counts down from: $tArE9$ to $tArE0$.

 To cancel the specified tA value, press this button.

 To continue with the specified tA value, press this button OR let the count complete.

Set a tA value, the alarm function uses values calculated from the calibrated range and the pressure value on the display.

Tare - With FSO values

To make sure that there is an indication of the correct pressure while tare is *On*, the FSO Low and/or FSO High values are not used.

Menu:  Monitor maximum/minimum

Use this function to monitor the maximum and minimum pressure. It uses the specified scan rate (refer to Menu:Set scan rate).

To save battery power (recommended), use an external power supply with this function.

Maximum/minimum - Set-up and use

Menu: Set this function to *On* (Refer to Menu operation).

When this function is *On*, use steps **1 + 2** to show the maximum/minimum since the last reset.

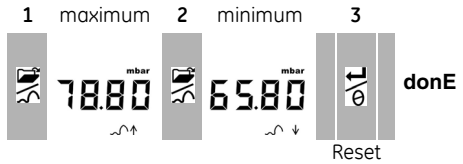

Step **3** resets the values for maximum/minimum. Press and hold.

Menu:  Monitor a pressure switch

Use this function to measure the performance of a pressure switch (mechanical operation and hysteresis). It uses the specified scan rate (refer to Menu:Set scan rate).

To save battery power (recommended), use an external power supply with this function.

Pressure switch input -
Set-up and use

1. Connect the DPI 104-IS (Figure 2/Table 5).
2. Menu: Set this function to *On* (refer to Menu operation).

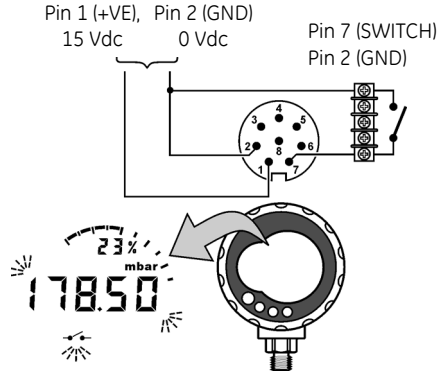



Figure 2: Example configuration - Switch input

Figure 2 shows the display when the switch condition changes (open or closed). The analogue dial and the % indication continue to monitor the normal pressure.

The switch symbol and the value on the main display flash to give the switch condition and the switch pressure.

 To reset the monitor function, press this button.

Menu: Calibration

Refer to the Calibration section.

Menu:  Set low/high alarm

Use the alarm function to show when the pressure is not in the specified limits for the system.

Set applicable values in the range 0 to 105% FSO:

$$\%FSO = [\text{Applied Pressure} / (\text{FSO High} - \text{FSO Low})] * 100$$

Note: Setting a tare value, the alarm function uses the calibrated range and the pressure value on the display (Refer to Menu: Set tare (or set zero)).

The alarm indication is available on the display and as a signal output (Table 5). Figure 3 shows an example configuration.

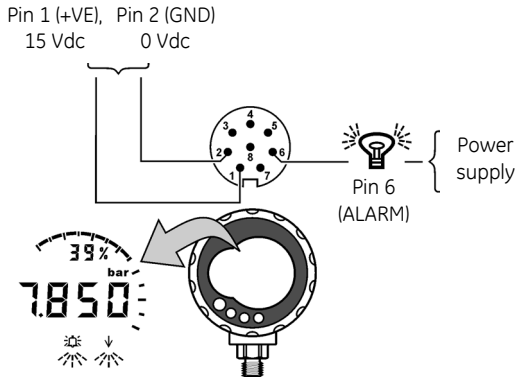

Figure 3: Example configuration - Alarm output

While there is an alarm condition, the applicable alarm symbol (high or low) flashes on the display (A2: item 15).

To save battery power (recommended), use an external power supply with this function.

Low/high alarm - Set-up and use

Menu: Set this function to *On* (refer to Menu operation). Then use these steps to set the low and/or high alarm.

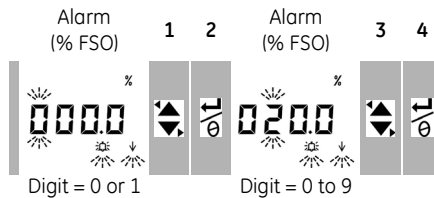

5. To finish, repeat steps **3 + 4** for each digit.

If the entered value is not correct, the value resets to the nearest permitted value. That is:

- a value in the range 0 to 105% FSO
- a low alarm value < high alarm value

To accept or change the new value, repeat steps **1 to 5**.



To cancel the new value, press this button.

Menu: Set automatic power OFF

Use this function to save battery power. The power goes off a specified period after the last button or external software operation. To get the maximum battery life, use (recommended) this function.

Note: The DPI 104-IS uses a small quantity of power while it is OFF. If putting in storage for a long period, disconnect the battery (refer to Installation).

Automatic power OFF - Set-up and use

Menu: Set this function to *On*. Then set an applicable value in the range 1 to 99 minutes (refer to Menu operation).

Note: If continuous operation is important, set this function to OFF and use an external power supply.

Menu:  Set lock code

Use the lock function to prevent accidental changes to the configuration. There are two options:

- *Lock code < 500*: This locks the menu and the tare function. Factory code = 000.
- *Lock code > 499*: This locks the menu but still use the zero option to set a tare value.

Refer to Menu: Set tare (or set zero).

Lock code - Set-up and use

Menu: Set this function to *On* (refer to Menu operation). Then use these steps to set a new code.

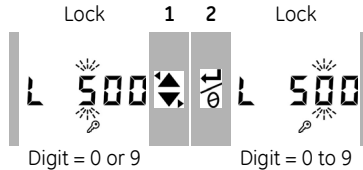

3. To finish the lock code, repeat steps **1 + 2** for each digit.

The next change to the menu options, the display shows: L - - -

Enter the applicable code. To reset the code to the factory code, do a restore operation (refer to Maintenance).

Menu: Set scan rate

This function sets the rate that the DPI 104-IS uses to take pressure samples from the internal sensor.

The nominal update rate for the display is 2 Hz. The update rate for the maximum/minimum function and the switch function is greater than or equal to the specified scan rate.

Note: Increasing the scan rate, increases the power consumption.

Scan rate - Set-up and use

Menu: Set an applicable value in the range 2 to 10 Hz (refer to Menu operation).

Menu: Set FSO low/high registers

Use the FSO low/high registers to set a different range for these functions: analogue display, % indication, low/high alarm.

Initially, these register values are set to the factory calibration values. Example:

Calibrated range: 0.7 bar (10 psi) gauge.

Selected units: mbar

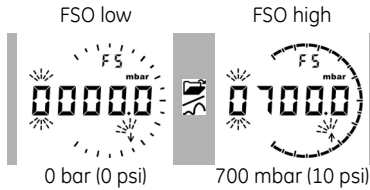

Table 7 gives the permitted alternative values that can be used.

Table 7: Permitted FSO values

Range	Permitted FSO values
All ranges: a, sg	0 to 105% FS
g: 0.7 bar (10 psi)	-0.7 bar (-10 psi) to 105% FS
g: ≥ 2 bar (30 psi)	-1 bar (-15 psi) to 105% FS
All ranges	FSO low < FSO high

**FSO low/high registers -
Set-up and use**

Menu: Set the menu option to the FSO low register (refer to Menu operation). Then use these steps to set an applicable value in the permitted range (Table 7):

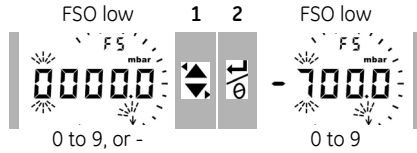

3. Repeat steps 1 + 2 for each digit and for the decimal point. If the value entered is not correct, the value resets to the nearest permitted value (Table 7).

To accept or change the new value, repeat steps 1 to 3.

 To cancel the new value, press this button.

4. If necessary, repeat the procedure for the FSO high register.

Software connections



Use external software with the DPI 104-IS: SiCal PRO monitor and control software; Intecal calibration software. To use this RS232 function, the DPI 104-IS must have connections to an external power supply (Figure 4/Table 5).

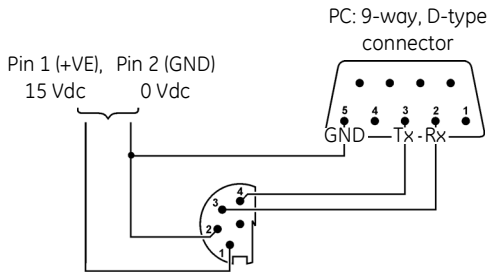

Figure 4: Example configuration: RS232

Using SiCal PRO, all the menu commands and display data are available.

Note: To use SiCal PRO, it must have the serial number for each unit in use with (DPI 104-IS, IDOS UPM, PC6-IDOS). Please supply the necessary serial numbers with an order or contact us at www.gesensinginspection.com.

 When the DPI 104-IS transmits or receives data, it shows this symbol.

Table 8: Error codes/indications

Code	Description
E0001	Incorrect unlock code. Use the correct code.
E0002	The tare facility is not available because the menu lock is <i>On</i> and the lock code < 500. Change the menu configuration.
E0004	Start up error. Do a restore operation (refer to Maintenance).
E0006	Incorrect calibration access code. Use the correct code.
E0007	The power supply is too low to do a calibration. Use an external power supply or replace the battery.
OLoAd	Applied pressure \geq 110% FS. Reduce the pressure.
99999/ -9999	There are not enough digits in the main display to give the correct pressure value. Change the measurement units.

Maintenance

Clean the case with a moist, lint-free cloth and a weak detergent. Do not use solvents or abrasive materials.

Make sure that there is no damage to the threads and o-rings, and that they are free of grit and other obstructions.

Do not try to do repairs to this instrument. Return the instrument to the manufacturer or an approved service agent.

Do not dispose of this product as household waste. Use an approved organisation that collects and/or recycles waste electrical and electronic equipment.

For more information, contact one of these:

- our customer service department
(Contact us at www.gesensinginspection.com).
- your local government office.

Replace the batteries

To replace the batteries, refer to Installation. All the configuration options stay in memory.

Restore the original configuration

If it is necessary to restore the unit to the original factory configuration, press and hold all four buttons until the display goes off (\approx five seconds). The unit then restarts.

Menu operation shows the factory settings. The lock code is reset to the factory code (000).

Calibration

Return (recommended) the DPI 104-IS to the manufacturer or an approved service agent for calibration.

Note: GE can provide a calibration service that is traceable to international standards.

If using an alternative calibration facility, make sure that it uses these standards.

Equipment and conditions

To do an accurate calibration, requires:

- the calibration equipment specified in Table 9.
- a stable temperature environment: $20 \pm 1^\circ\text{C}$ ($68 \pm 2^\circ\text{F}$).

Table 9: Calibration equipment

Function	Calibration equipment
Pressure	An applicable pressure standard (primary or secondary) with a total uncertainty of 0.01% reading or better. Make the pressure connection to A1: item 4 (refer to Installation).

Procedures

1. Connect the applicable calibration equipment (Table 9).
2. Menu: Set the menu option to C _____. Then set the calibration access code = last four digits of the serial number (refer to Menu operations).

There are two calibration options (Table 10):

Table 10: Calibration options

Option	Description
C0:	Set the necessary offset value for the instrument to give the correct pressure related to zero: All ranges g or sg: Zero (bar/psi); Ranges a: Ambient pressure*
C2:	Do a two-point pressure calibration. All ranges g or sg: P1 = Zero (bar/psi); P2* = FS Ranges a: P1* = Ambient pressure; P2* = FS

* adjustable by 5% FS

C0 (Zero offset)

The DPI 104-IS shows these displays:

1. The calibration point to be used for C0. This value is only adjustable for an absolute type DPI 104-IS (Table 10).
C0 - Gauge = 0000.0

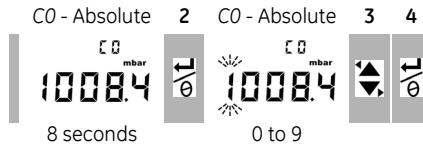

5. Repeat steps 3 + 4 for each digit and for the decimal point. The value is ignored if it is not in the permitted limits (Table 10).

This value is then used as the Set Point (SP) on the subsequent displays.

6. This sequence of displays will follow:

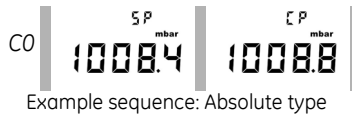

The SP value is followed by the measured pressure - Current Pressure (CP). This sequence continues until the offset value is accepted or rejected .

7. When the pressure is stable:

 To accept the new offset value, press this button. The display shows “donE”, and then the next calibration option (C2).

 To reject the new offset value and move to the next calibration option (C2), press this button.

The value is ignored if it is not in the permitted limits (5% FS) or if the CP value is not stable.

C2 (two-point pressure calibration)

Point 1 (P1) - The DPI 104-IS shows these displays:

1. The calibration point to be used for C2 - Point 1. This value is only adjustable for an absolute type DPI 104-IS (Table 10).
C2 - Point 1 (Gauge) = 0000.0

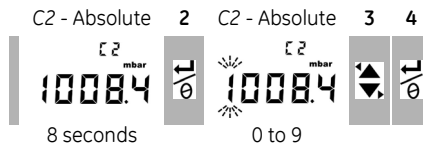



- Repeat steps **3 + 4** for each digit and for the decimal point. The value is ignored if it is not in the permitted limits (Table 10).
This value is then used as the Set Point (SP) for point 1 on the subsequent displays.
- This sequence of displays will follow:



Example sequence: Absolute type

The *SP* value is followed by the measured pressure - *CP*. This sequence continues until the point 1 value is accepted or rejected.

- When the pressure is stable:

-  To accept the new *P1* value, press this button. The display shows the calibration point *C2* - point 2 (*C2*).
-  To reject the new *P1* value and move to the next menu option, press this button.

The value is ignored if it is not in the permitted limits (5% FS) or if the *CP* value is not stable.

Point 2 (P2) - Use the same steps (**1** to **5** above) to set *C2* - Point 2. This is the FS value and it is adjustable for the absolute and gauge type DPI 104-IS (Table 10).



- This sequence of displays will follow:



Example sequence: Absolute type

The *SP* value is followed by the measured pressure - *CP*. This sequence continues until the point 2 value is accepted or rejected.

- When the pressure is stable:

-  To accept the new *P2* value, press this button. The display shows "donE", and does a two-point calibration. The instrument then restarts.
-  To reject the new *P2* value and move to the next menu option, press this button.

The value is ignored if it is not in the permitted limits (5% FS) or if the *CP* value is not stable.

Specification

General

Operating temperature	-10 to 50°C (14 to 122°F)
Storage temperature	-20 to 70°C (-4 to 158°F)
Ingress Protection	IP65 (Dust-tight, jets of water)
Materials	Case: Anti-static Acrylonitrile Butadiene Styrene/Polycarbonate (ABS/PC) Keypad: Anti-static silicone rubber O-ring: Nitrile rubber with silicone grease RS232 socket: Nickel-plated brass Vent filter: PTFE Refer also to <i>Media notes</i> .
Humidity	0 to 95% without condensation (Def Stan 66-31, 8.6 cat III)
Shock/Vibration	BS EN 60079-11:2007; Def Stan 66-31, 8.4 cat III
EMC	BS EN 61326: refer to appendix A
Safety	Electrical - BS EN 61010-1:2001; Pressure Equipment Directive - Class: Sound Engineering Practice (SEP); hazardous areas (Refer to appendices: A, B)
Approved	Refer to appendices: A, B; CE Marked
Size	Diameter = 95 mm (3.74 in); Depth = 55 mm (2.2 in) Typical length (with connector) ≈ 120 mm (4.7 in)
Weight	325 g (11.5 oz)
Power supply	Battery: Duracell® Procell® 9V, Alkaline (MN1604); OR Use an external 15 Vdc supply
Battery life	Up to four months for pressure measurements: Au (power save facility) - On; maximum/minimum, alarm, switch - All set to OFF

Electrical

Switch input	Maximum impedance: 200Ω (mechanical contact only). Maximum (mA/V): refer to Figure B2.
Alarm output	Type: Open drain Field Effect Transistor (FET). Maximum (mA/V): refer to Figure B2.
RS232	For: external software

Pressure measurement

Range: gauge (g), absolute (a), sealed gauge (sg)			Resolution		Maximum Working Pressure (MWP)		Media notes
bar	psi	Type	mbar	psi	bar	psi	
0 to 0.7	0 to 10	g*	0.01	0.001	0.77	11.2	1
0 to 2.0	0 to 30	g* or a	0.1	0.001	2.2	32	1
0 to 7.0	0 to 100	g* or a	0.1	0.01	7.7	111.7	2
0 to 20	0 to 300	g* or a	1	0.01	22	319	2
0 to 70	0 to 1000	g* or a	1	0.1	77	1117	2
0 to 200	0 to 3000	sg	10	0.1	220	3190	2
0 to 350	0 to 5000	sg	10	0.1	385	5583	2
0 to 700	0 to 10000	sg	10	1	770	11165	2
0 to 1000	0 to 15000	sg	100	1	1100	15950	3
0 to 1400	0 to 20000	sg	100	1	1540	22330	3

* All gauge models can measure negative pressures (not part of the calibrated range)

Media notes:

1. Non-corrosive, non-conductive liquid or non-corrosive, dry gas
2. Media applicable to stainless steel (316)
3. Media applicable to Inconel 625

Accuracy (0 to FS)	0.7 bar (10 psi): 0.15% FS All ranges \geq 2 bar (30 psi): 0.05% FS
Units	kPa, MPa, kg/cm ² , psi, mbar, bar, mmHg, mmH ₂ O, mH ₂ O, inH ₂ O, inHg
Pressure connections	Ranges \leq 700 bar (10000 psi): 1/4 NPT male OR G1/4 male Ranges > 700 bar (10000 psi): 9/16 x 18 male cone



GE Druck

EC Declaration of Conformity

Product: DPI 104-IS PORTABLE PRESSURE INDICATOR

The above product(s) meets the protection requirements of the relevant EC Directives.

Supplier: Druck Ltd., Fir Tree Lane, Groby, Leicester LE6 0FH.
Tel: +44 (0) 116 231 7100 Fax: +44 (0) 116 231 7101

Signed: *R. Jones*
For and on behalf of Druck Limited

Date: 28th July 2010

Name: R. E. Jones

Position: Chief Engineer

Relevant European Directives	
Directive Name	Directives
ATEX Directive	94/9/EC †
Electromagnetic Compatibility (EMC)	2004/108/EC
Low Voltage Directive (LVD)	2006/95/EC ‡

† The ATEX directive only applies to apparatus marked with certificate number ITS07ATEX25517X
‡ The LVD directive only applies to the optional power supply unit, GE Druck P/N 191-350

NOTES:

The apparatus must be used in accordance with its specifications, especially (but not limited to) pressure and temperature limits.

ATEX DIRECTIVE

The apparatus design has been subject to assessment for the following type of protection:

- Intrinsically Safe (Ex ia), for Group II Category 1 G equipment – Ex ia IIC T4 Ga – EC Type-Examination Certificate no. ITS07ATEX25517X

The apparatus' design was assessed to the following harmonized standards:

- EN 60079-0: 2009 General requirements
- EN 60079-11: 2007 Equipment protection by intrinsic safety "i"
- EN 60079-26: 2007 Equipment with equipment protection level (EPL) Ga

The type-examination for the above apparatus' design was carried out by Intertek (notified body number 0359) – Intertek Testing & Certification Ltd, Intertek House, Cleeve Road, Leatherhead, Surrey KT22 7SB, United Kingdom.

The apparatus must be used in accordance with the supplied instructions for hazardous area equipment, K0436.

EMC DIRECTIVE

When appropriately installed the apparatus meets and exceeds the following Commercial and Industrial specifications:

- EN 61326-1: 2006 Electrical equipment for measurement, control and laboratory use. EMC requirements. General requirements

LVD DIRECTIVE

The CE mark was first affixed to the power supply unit in 2006. When appropriately installed the power supply unit meets and exceeds the following specifications:

- EN 60950-1:2006 Information technology equipment - Safety - Part 1: General requirements

PRESSURE EQUIPMENT DIRECTIVE

The product has been assessed as equipment of relatively low hazard and has been designed within the bounds of 'sound engineering practice' in line with the pressure equipment directive.

intentionally left blank



1. **EC-TYPE EXAMINATION CERTIFICATE**

2. **Equipment or Protective System Intended for use in Potentially Explosive Atmospheres Directive 94/9/EC**

3. EC-Type Examination Certificate Number: **ITS07ATEX25517X**

4. Equipment or Protective System: **DPI104IS**

5. Manufacturer: **DRUCK LTD**

6. Address: **Fir Tree Lane, Groby, Leicester, LE6 0FH. United Kingdom**

7. This equipment or protective system and any acceptable variation thereto is specified in the schedule to this certificate and the documents therein referred to.

8. Intertek Testing and Certification Limited, notified body number 0359 in accordance with Article 9 of the Council Directive 94/9/EC of 23 March 1994, certifies that this equipment or protective system has been found to comply with the Essential Health and Safety Requirements relating to the design and construction of equipment and protective systems intended for use in potentially explosive atmospheres given in Annex II to the Directive.

The examination and test results are recorded in confidential Report Number: Intertek Report Ref 06023459, dated June 2007

9. Compliance with the Essential Health and Safety Requirements has been assured by compliance with: EN 60079-0:2006, EN 60079-11:2007 and EN 60079-26:2004 except in respect of those requirements listed at item 18 of the Schedule.

10. If the sign "X" is placed after the certificate number, it indicates that the equipment or protective system is subject to special conditions for safe use specified in the schedule to this certificate.

11. This EC Type examination certificate relates only to the design, examination and tests of the specified equipment or protective system in accordance to the directive 94/9/EC. Further requirements of the Directive apply to the manufacturing process and supply of this equipment or protective system. These are not covered by this certificate.

12. The marking of the equipment or protective system shall include the following:-



II 1 G, EEx ia IIC T4 (Tamb = -10°C to 50°C)

A M Smart
Principal Engineer
4 July 2007

Intertek Testing & Certification Limited
Intertek House, Cleeve Road, Leatherhead, Surrey, KT22 7SB
Tel: + 44 (0)1372 370900 Fax: +44 (0)1372 370977
<http://www.uk.intertek-etisemko.com>
Registered No 3272281 Registered Office: 25 Savile Row London W1X 1AA

This certificate may only be reproduced in its entirety and without any change, schedule included and is subject to Intertek Testing and Certification Conditions for Granting Certification.

Intertek Industrial

13. SCHEDULE

14. EC-TYPE EXAMINATION CERTIFICATE NUMBER ITS07ATEX25517X

15. DESCRIPTION OF EQUIPMENT OR PROTECTIVE SYSTEM

The DPI104IS is a portable battery powered or external supply operated pressure indicator.

Provisions are provided for the RS232 (Rx and Tx), alarm and switch interfaces, all of which are powered from certified intrinsically safe barriers.

The DPI104IS consists of a printed circuit board (PCB) and a 9V battery, all housed within a two part circular plastic enclosure held together with a series of clips.

The PCB containing electronic components and solid partition is fixed to the lid with the display. The 9V battery with the battery cover is fitted to the base.

The enclosure provides a degree of protection of at least IP20.

The DPI104IS is powered by either a single Duracell Procell Type MN1604 9V alkaline battery or from an external IS certified power supply. The battery must only be changed in the non-hazardous area.

Intrinsic safety is assured by limitation of voltage, current and power, limitation of capacitance and inductance and infallible segregation and use of specified battery.

The maximum intrinsically safe input and output parameters are as follows:

Power:

$U_i = 16.9 \text{ V}$

$I_i = 22 \text{ mA}$

$P_i = 0.21 \text{ W}$

$C_i = 0$

$L_i = 1.6 \mu\text{H}$

Alarm:

$U_i = 16.9 \text{ V}$

$I_i = 22 \text{ mA}$

$P_i = 0.21 \text{ W}$

$C_i = 100 \text{ pF}$

$L_i = 0$

$U_o = 5 \text{ V}$

$I_o = 0.5 \text{ mA}$

$P_o = 0.69 \text{ mW}$

$C_o = 99.9 \mu\text{F}$

$L_o = 1 \text{ H}$

Switch:

$U_o = 5 \text{ V}$

$I_o = 6.75 \text{ mA}$

$P_o = 8.5 \text{ mW}$

$C_o = 100 \mu\text{F}$

$L_o = 1 \text{ H}$

Intertek Testing & Certification Limited
Intertek House, Cleeve Road, Leatherhead, Surrey, KT22 7SB

Tel: + 44 (0)1372 370900 Fax: +44 (0)1372 370977

<http://www.uk.intertek-etlsemko.com>

Registered No 3272281 Registered Office: 25 Savile Row London W1X 1AA

This certificate may only be reproduced in its entirety and without any change, schedule included and is subject to Intertek Testing and Certification Conditions for Granting Certification.

Sheet 2 of 4

Intertek Industrial

13. SCHEDULE

14. EC-TYPE EXAMINATION CERTIFICATE NUMBER ITS07ATEX25517X

Tx:

$U_i = 16.2 \text{ V}$
 $I_i = 4.75 \text{ mA}$
 $P_i = 0.21 \text{ W}$

$C_i = 440 \text{ nF}$
 $L_i = 0$

$U_o = 10 \text{ V}$

$I_o = 14 \text{ mA}$
 $P_o = 0.26 \text{ W}$

$C_o = 2 \text{ nF}$
 $L_o = 0.41 \text{ H}$

Rx:

$U_i = 16.2 \text{ V}$
 $I_i = 4.75 \text{ mA}$
 $P_i = 0.21 \text{ W}$

$C_i = 440 \text{ nF}$
 $L_i = 0$

$U_o = 10 \text{ V}$

$I_o = 14 \text{ mA}$
 $P_o = 0.26 \text{ W}$

$C_o = 2 \text{ nF}$
 $L_o = 0.41 \text{ H}$

16. REPORT NUMBER

Intertek Report Ref 06023459, dated June 2007.

17. SPECIAL CONDITIONS FOR SAFE USE

1. When the DPI104IS is powered via the 8-way connector the cable used must be a Type A or a Type B in accordance with the requirements of IEC 60079-14.

18. ESSENTIAL HEALTH AND SAFETY REQUIREMENTS (EHSR'S)

The relevant EHSR's that have not been addressed by the standards listed in this certificate have been identified and assessed in Intertek Report Ref 06023459 dated June 2007.

Intertek Testing & Certification Limited
Intertek House, Cleeve Road, Leatherhead, Surrey, KT22 7SB
Tel: + 44 (0)1372 370900 Fax: +44 (0)1372 370977
<http://www.uk.intertek-etlsemko.com>
Registered No 3272281 Registered Office: 25 Savile Row London W1X 1AA

This Certificate is the property of Intertek Testing and Certification Ltd and is subject to Intertek Testing and Certification Conditions for Granting Certification.

Intertek Industrial

13. SCHEDULE

14. EC-TYPE EXAMINATION CERTIFICATE NUMBER ITS07ATEX25517X

19. DRAWINGS

Number	Sheets	Rev	Date	Description
X-A4-0275	1	1	27.06.07	Battery Cover Label
X-A4-0280	1	1	27.06.07	Case Printing and Label Text
X-A2-0271	2	2	27.06.07	Circuit Layout
X-A4-0273	2	1	27.06.07	Main PCI
X-A2-0276	1	1	27.06.07	Rubber Keypad
X-A2-0277	2	1	27.06.07	Moulded Case Back
X-A4-0278	1	1	27.06.07	Window
X-A2-0279	1	1	27.06.07	Moulded Bezel
X-A4-0281	1	1	27.06.07	Sensor Cable Assembly
X-A4-0282	1	1	27.06.07	RS232 Cable Assembly
X-A3-0283	1	1	27.06.07	Instrument Assembly
X-A4-0286	1	1	27.06.07	Keypad Printing Details
X-A3-0269	3	2	27.06.07	Circuit Drawing
X-A3-0269 BOM	2	2	27.06.07	Bill of Materials

Intertek Testing & Certification Limited
Intertek House, Cleeve Road, Leatherhead, Surrey, KT22 7SB
Tel: + 44 (0)1372 370900 Fax: +44 (0)1372 370977
<http://www.uk.intertek-etlsemko.com>
Registered No 3272281 Registered Office: 25 Savile Row London W1X 1AA

This Certificate is the property of Intertek Testing and Certification Ltd
and is subject to Intertek Testing and Certification Conditions for Granting Certification.

Sheet 4 of 4



1. **SUPPLEMENTARY EC-TYPE EXAMINATION CERTIFICATE**
2. **Equipment or Protective System Intended for use in Potentially Explosive Atmospheres Directive 94/9/EC**
3. Supplementary EC-Type Examination Certificate Number: **ITS07ATEX25517X/1**
4. Equipment or Protective System: **DPI104IS**
5. Manufacturer: **DRUCK LTD**
6. Address: **Fir Tree Lane, Groby, Leicester, LE6 0FH. United Kingdom**
7. This supplementary certificate extends EC-Type Examination Certificate Number ITS07ATEX25517X to apply to equipment or protective systems designed and constructed in accordance with the specification set out in the Schedule of the said Certificate but having variations specified in the Schedule attached to this certificate and the documents therein referred to.

Intertek Report Ref 07028856 dated January 2008

This Supplementary Certificate shall be held with the original Certificate

A M Smart
Deputy Certification Officer
15 January 2008

Intertek Testing & Certification Limited
Intertek House, Cleeve Road, Leatherhead, Surrey, KT22 7SB
Tel: + 44 (0) 1372 370900 Fax: +44 (0) 1372 370977
<http://www.etlsemko.com/uk>
Registered No 3272281 Registered Office: 25 Savile Row London W1X 1AA

This Certificate is the property of Intertek Testing and Certification Ltd
and is subject to Intertek Testing and Certification Conditions for Granting Certification.

Schedule

SUPPLEMENTARY EC-TYPE EXAMINATION CERTIFICATE NUMBER ITS07ATEX25517X/1

VARIATION ONE

Description of the Variation to the Equipment or Protective System.

To permit the following changes

- a) Change to the PCA assembly to incorporate a plastic clip to provide a degree of protection of at least IP20 on the PCA circuit board.
- b) Change in value of components L1 (from 1.3 μ H 10% to 10 μ H 10%) and LC1-3 (from 30nH 10% to 37nH 20%).
- c) Change in associated documents to reflect the above changes and other minor changes to the non-safety components.

Report No.

Intertek Report Ref 07028856 dated January 2008

SPECIAL CONDITIONS FOR SAFE USE

See original certificate

Essential Health and Safety Requirements

See original certificate

Drawings

Number	Issue	Date	Description
X-A3-0299	2	21.11.2007	DPI104IS Bill of Materials (2 sheets)
X-A3-0283	2	21.11.2007	DPI104IS Instrument Assembly
X-A3-0269	3	10.01.08	DPI104IS Circuit Diagram (3 sheets)

Intertek Testing & Certification Limited
Intertek House, Cleeve Road, Leatherhead, Surrey, KT22 7SB
Tel: + 44 (0) 1372 370900 Fax: +44 (0) 1372 370977
<http://www.etisemko.com/uk>
Registered No 3272281 Registered Office: 25 Savile Row London W1X 1AA

This Certificate is the property of Intertek Testing and Certification Ltd
and is subject to Intertek Testing and Certification Conditions for Granting Certification

Sheet 2 of 2



1. **SUPPLEMENTARY EC-TYPE EXAMINATION CERTIFICATE**
2. **Equipment or Protective System Intended for use in Potentially Explosive Atmospheres Directive 94/9/EC**
3. Supplementary EC-Type Examination Certificate Number: **ITS07ATEX25517X/2**
4. Equipment or Protective System: **DPI104IS**
5. Manufacturer: **DRUCK LTD**
6. Address: **Fir Tree Lane, Groby, Leicester, LE6 0FH. United Kingdom**
7. This supplementary certificate extends EC-Type Examination Certificate Number ITS07ATEX25517X to apply to equipment or protective systems designed and constructed in accordance with the specification set out in the Schedule of the said Certificate but having variations specified in the Schedule attached to this certificate and the documents therein referred to.

Intertek Report Ref 10045651 dated May 2010

This Supplementary Certificate shall be held with the original Certificate

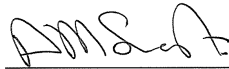

A M Smart
Certification Officer
26 May 2010

Intertek Testing & Certification Limited
Intertek House, Cleeve Road, Leatherhead, Surrey, KT22 7SB
Tel: + 44 (0) 1372 370900 Fax: +44 (0) 1372 370977
<http://www.etlsemko.com/uk>
Registered No 3272281 Registered Office: 25 Savile Row London W1X 1AA

This Certificate is the property of Intertek Testing and Certification Ltd and is subject to Intertek Testing and Certification Conditions for Granting Certification.

Sheet 1 of 3



Schedule

SUPPLEMENTARY EC-TYPE EXAMINATION CERTIFICATE NUMBER ITS07ATEX25517X/2

VARIATION TWO

Description of the Variation to the Equipment or Protective System.

To permit the following changes

- a) Addition of the option of a protective rubber boot for DPI104IS equipment.
- b) Update the certificate to the latest harmonised standards listed below:

EN 60079-0:2009

EN 60079-11:2007

EN 60079-26:2007

New coding:

 II 1G Ex ia IIC T4 Ga (-10°C ≤Ta ≤50°C)

Report No.

Intertek Report Ref 10045651 dated May 2010

SPECIAL CONDITIONS FOR SAFE USE

See original certificate

Essential Health and Safety Requirements

See original certificate

Intertek Testing & Certification Limited
Intertek House, Cleeve Road, Leatherhead, Surrey, KT22 7SB
Tel: + 44 (0) 1372 370900 Fax: +44 (0) 1372 370977
<http://www.etlsemko.com/uk>
Registered No 3272281 Registered Office: 25 Savile Row London W1X 1AA

This Certificate is the property of Intertek Testing and Certification Ltd
and is subject to Intertek Testing and Certification Conditions for Granting Certification

Sheet 2 of 3

Schedule

SUPPLEMENTARY EC-TYPE EXAMINATION CERTIFICATE NUMBER ITS07ATEX25517X/2

Drawings

Number	Issue	Date	Description
X-A2-0342	1	11/02/2010	DPI104IS Moulded rubber boot
X-A4-0280 (2 sheets)	2	11/02/2010	DPI104IS Case printing and label text

This Certificate is for the exclusive use of Intertek's client and is provided pursuant to the agreement between Intertek and its Client. Intertek's responsibility and liability are limited to the terms and conditions of the agreement. Intertek assumes no liability to any party, other than to the Client in accordance with the agreement, for any loss, expense or damage occasioned by the use of this Certificate. Only the Client is authorized to permit copying or distribution of this Certificate and then only in its entirety. Any use of the Intertek name or one of its marks for the sale or advertisement of the tested material, product or service must first be approved in writing by Intertek.

Intertek Testing & Certification Limited
Intertek House, Cleeve Road, Leatherhead, Surrey, KT22 7SB
Tel: + 44 (0) 1372 370900 Fax: +44 (0) 1372 370977
<http://www.etlsemko.com/uk>
Registered No 3272281 Registered Office: 25 Savile Row London W1X 1AA

This Certificate is the property of Intertek Testing and Certification Ltd
and is subject to Intertek Testing and Certification Conditions for Granting Certification

Approvals - IECEx

For the IECEx certificate (IECEx ITS 07.0007X), visit the IECEx website at:

www.iecex.com

Customer service

Visit our web site: www.gesensing.com

